

Unifold



UNIFOLD

THE EFFORTLESSLY SLIM
NEW FOLDING SLIDING
DOOR

With just a 120mm, glass-to-glass sightline,
UniFold will open up your room to the light and
bring the outside in, creating a functional, open
space for living, working and entertaining.

Slim 120mm glass-to-glass sightline

Fully Adjustable for ease of installation

Can achieve PAS 24 / Secured by design

Fully openable corners

Market beating prices

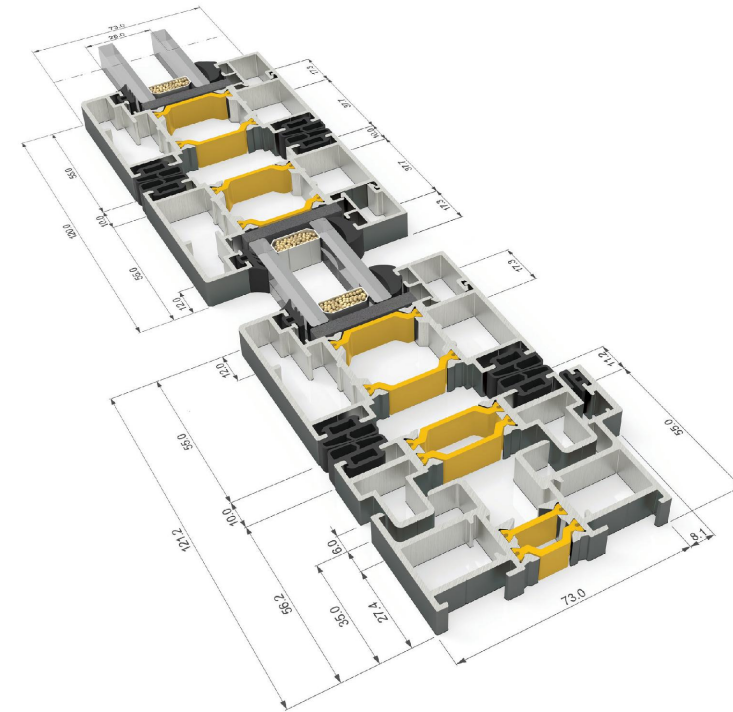

Size Limits

Maximum panel width	1200 mm
Maximum panel height	3000 mm
Maximum panel weight	120 kg

PERFORMANCE

U-VALUE	From 1.4 W/m ² K
AIR PERMEABILITY	Class 4
WATER TIGHTNESS	Class 9A
WIND RESISTANCE	Class A3

FRAME DEPTH	73 mm
GLAZING THICKNESS	24-44 mm
GLAZING METHOD	Internally beaded
MINIMUM SIGHTLINE	120 mm
ENHANCED SECURITY	PAS24

THRESHOLD HEIGHT

STANDARD	55 mm
DEEP	67.5 mm
LOW	40 mm
ULTRA LOW	20 mm

UNIFOLD - Contents

- 1.0 Typical Elevations
- 2.0 Standard Profiles
- 3.0 Typical Sections
 - 3.1 Threshold - Open Out
 - 3.2 Threshold - Low Threshold
 - 3.3 Threshold - Open In
 - 3.4 Head - Open Out
 - 3.5 Head - Open In
 - 3.6 Head - Trickle Vent + 20mm Add On
 - 3.7 Jamb - Hinged Open Out
 - 3.8 Jamb - Hinged Open In
 - 3.9 Interlock - T-Handle Open Out
 - 3.10 Interlock - T-Handle Open In
 - 3.11 Meeting - Traffic to Even Open Out
 - 3.12 Jamb - Traffic Door Open Out
 - 3.13 Jamb - Traffic Door Open In
 - 3.14 Meeting - Traffic to Odd Open Out
 - 3.15 Meeting - Even to Even Open Out
 - 3.16 Jamb - Even Configuration
 - 3.17 Threshold - Cill Options
 - 3.18 Threshold Cill Nose Option

UNIFOLD- Typical Elevations

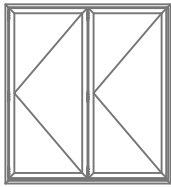

2 PANE - 220

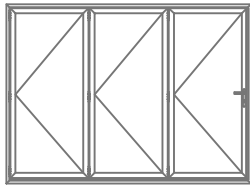

3 PANE - 330

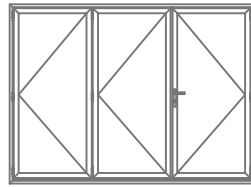

3 PANE - 321

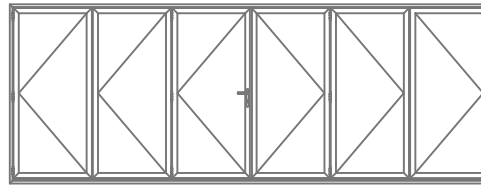

6 PANE - 633

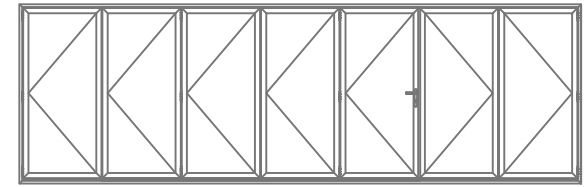

7 PANE - 752

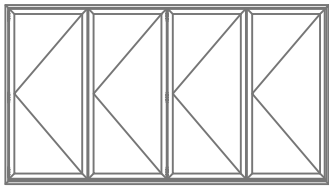

4 PANE - 440

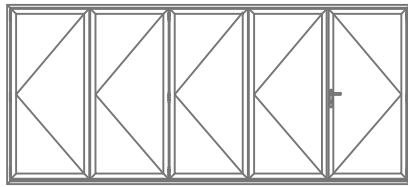

5 PANE - 541

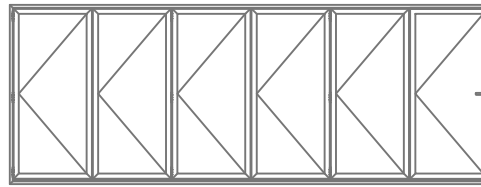

6 PANE - 660

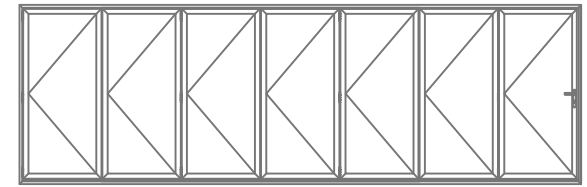

7 PANE - 770

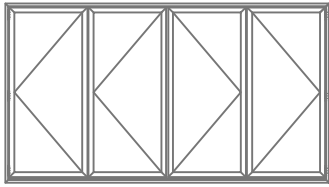

4 PANE - 422

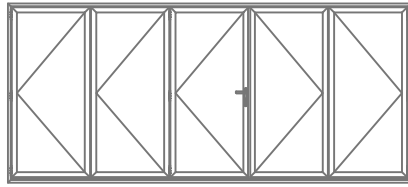

5 PANE - 532

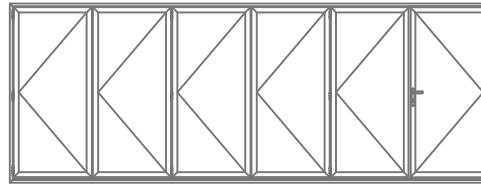

6 PANE - 651

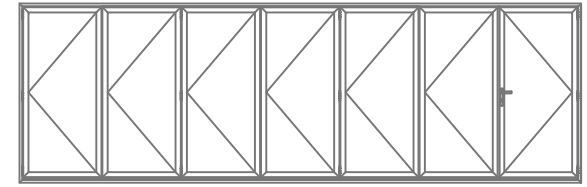

7 PANE - 761

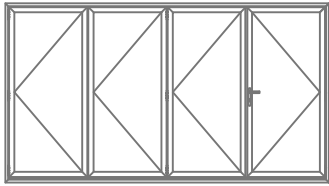

4 PANE - 431

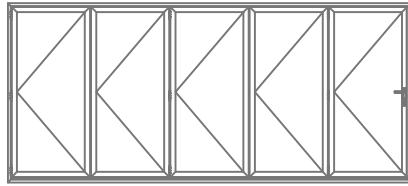

5 PANE - 550

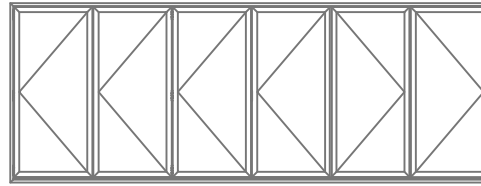

6 PANE - 642

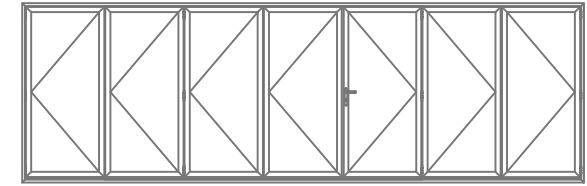

7 PANE - 743

LOW THRESHOLD OPTION AVAILABLE

OPEN IN AND OPEN OUT CONFIGURATIONS AVAILABLE

UNIFOLD- Standard Profiles

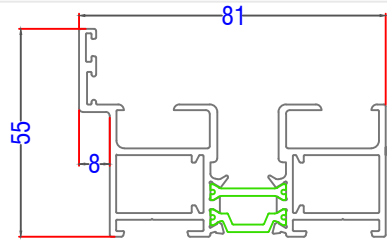

3731 - Outer Frame
(Head and Jamb)

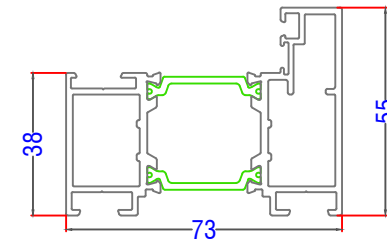

3721 - Slim Sash

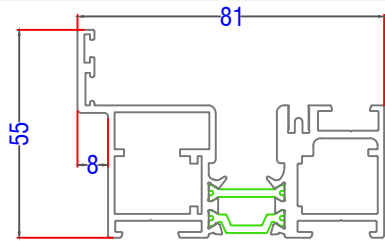

3730 - Outer Frame (Base)

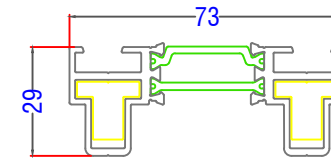

3740 - Adjustable Jamb

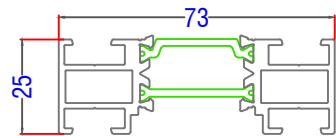

3741 - 25mm Extension Profile

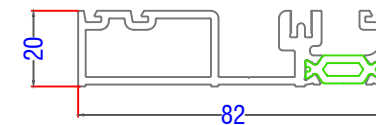

3740 - Low Threshold

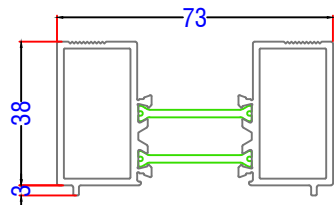

3795 - 38mm Extension Profile

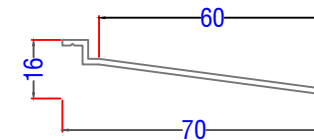

7056 - Cill Extension 70mm

BSF 70 - Standard Profiles

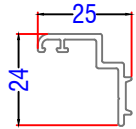

3746 - Swing Door Rebate (Adjustable Jamb)

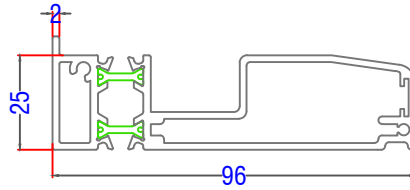

AL Uk AW570 - 95mm Stub Nose Cill

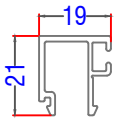

780 - 28mm DGU Glazing bead

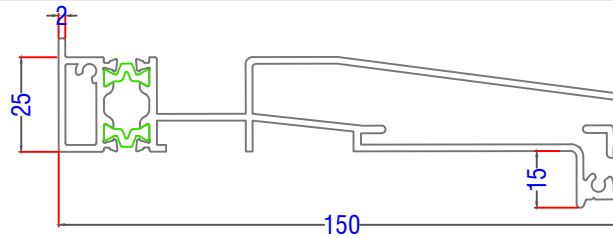

AL Uk AW542 - 150mm Drop Nose Cill

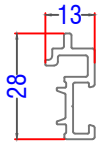

3743 - Multipoint lock add on

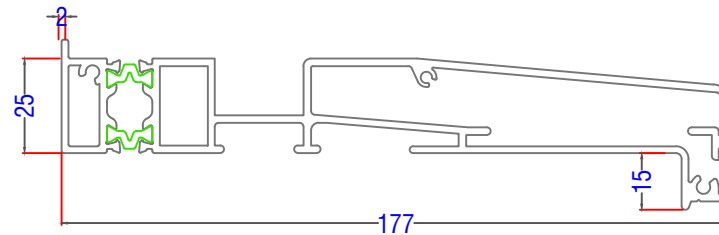

AL Uk AW543 - 177mm Drop Nose Cill

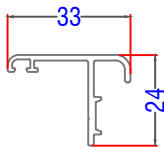

3745 - Swing Door Rebate

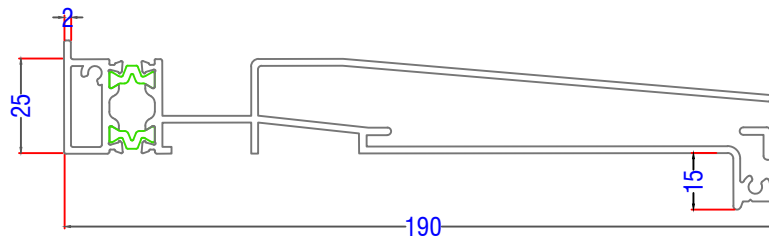

AL Uk AW544 - 190mm Drop Nose Cill

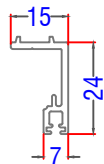

3725 - Sash Extension

UNIFOLD - Typical Sections

Threshold - Open Out

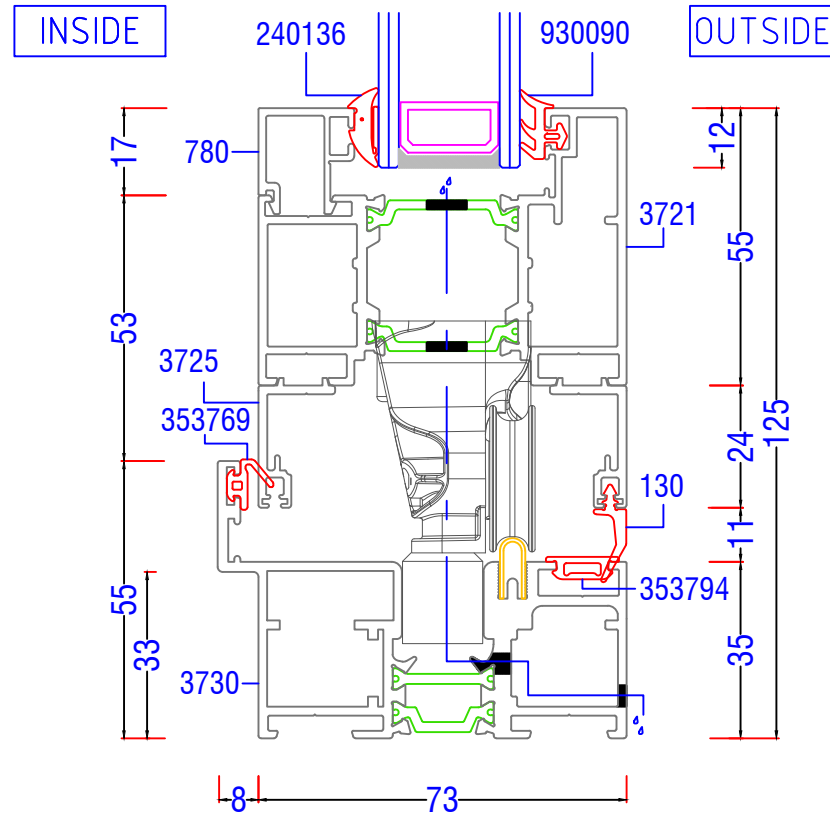
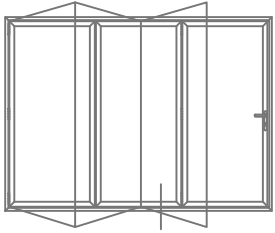

UNIFOLD - Typical Sections

Threshold - Low Threshold

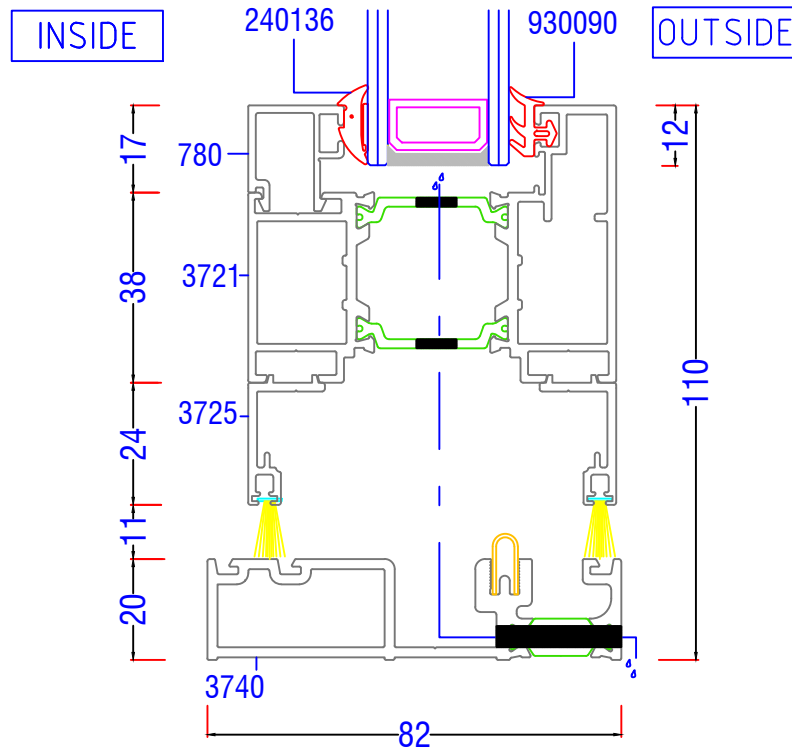
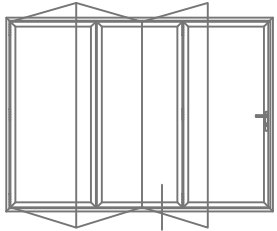

UNIFOLD - Typical Sections

Threshold - Open In

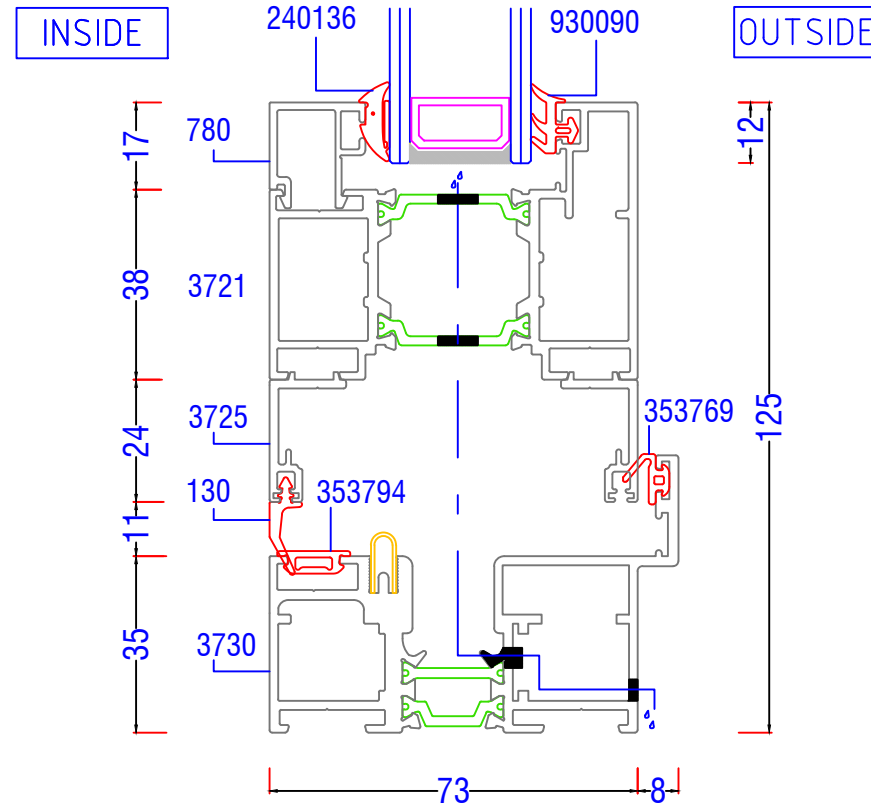
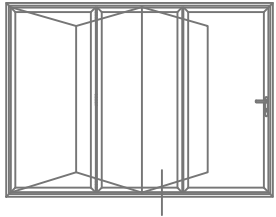

UNIFOLD - Typical Sections

Head - Open Out

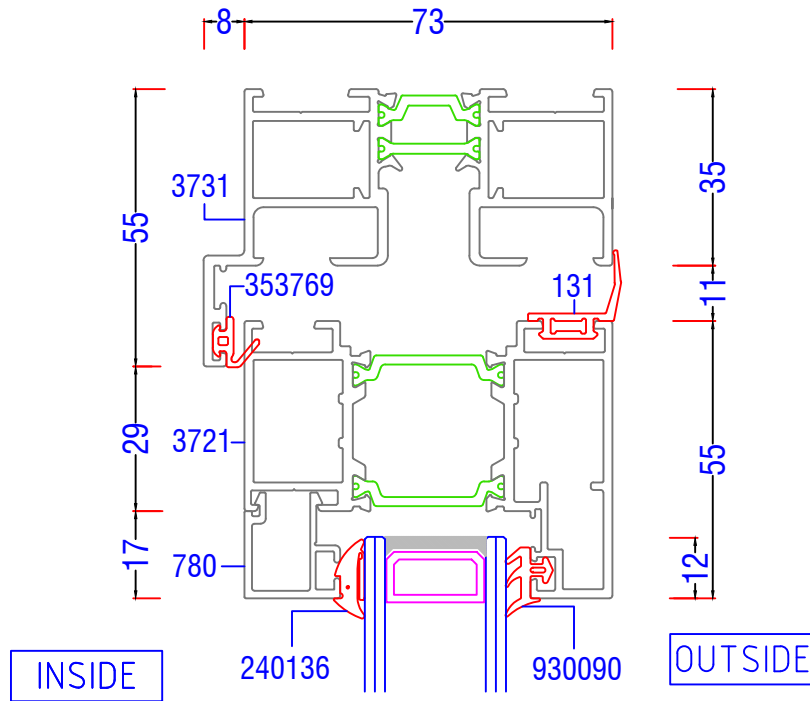
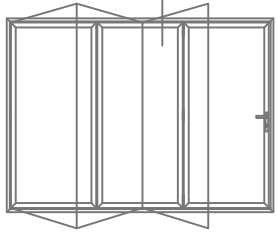

UNIFOLD - Typical Sections

Head - Open In

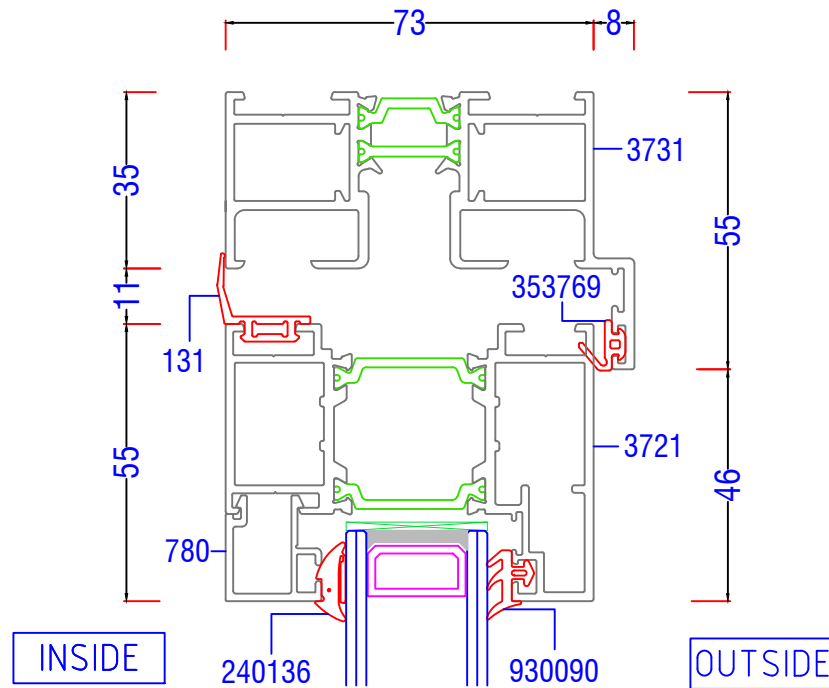
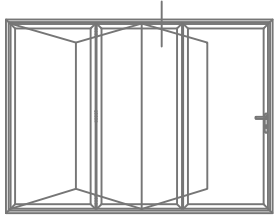

UNIFOLD - Typical Sections

Head - Open In with 20mm Extension + Trickle Vent

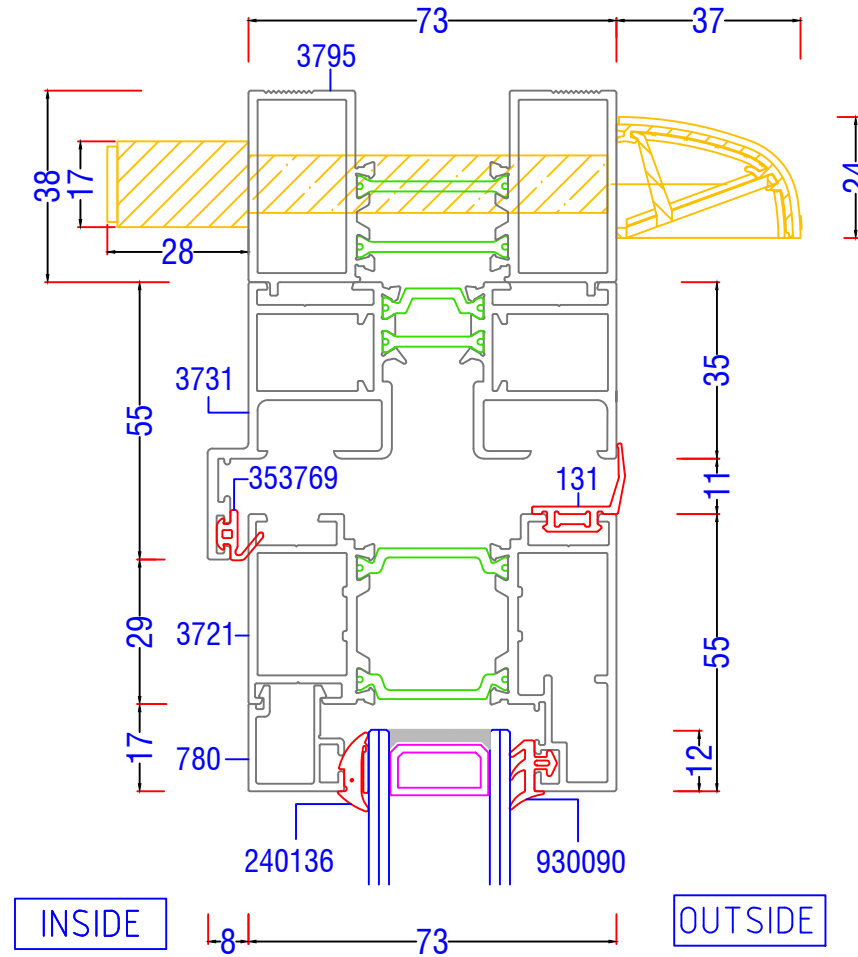
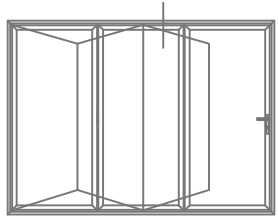

UNIFOLD - Typical Sections

Jamb - Hinged Open Out

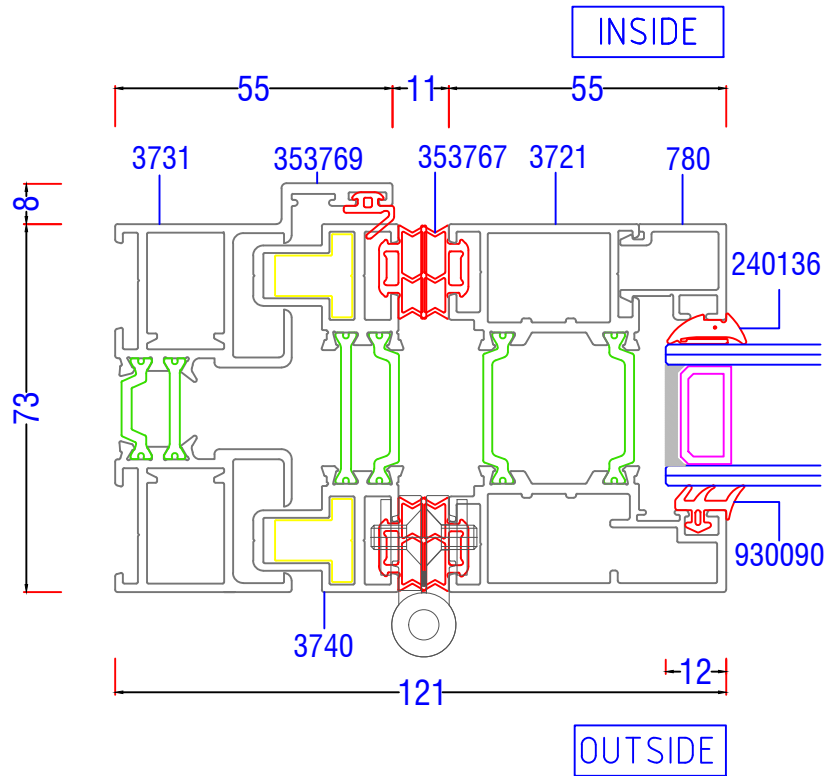
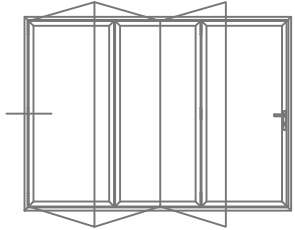

UNIFOLD - Typical Sections

Jamb - Hinged Open In

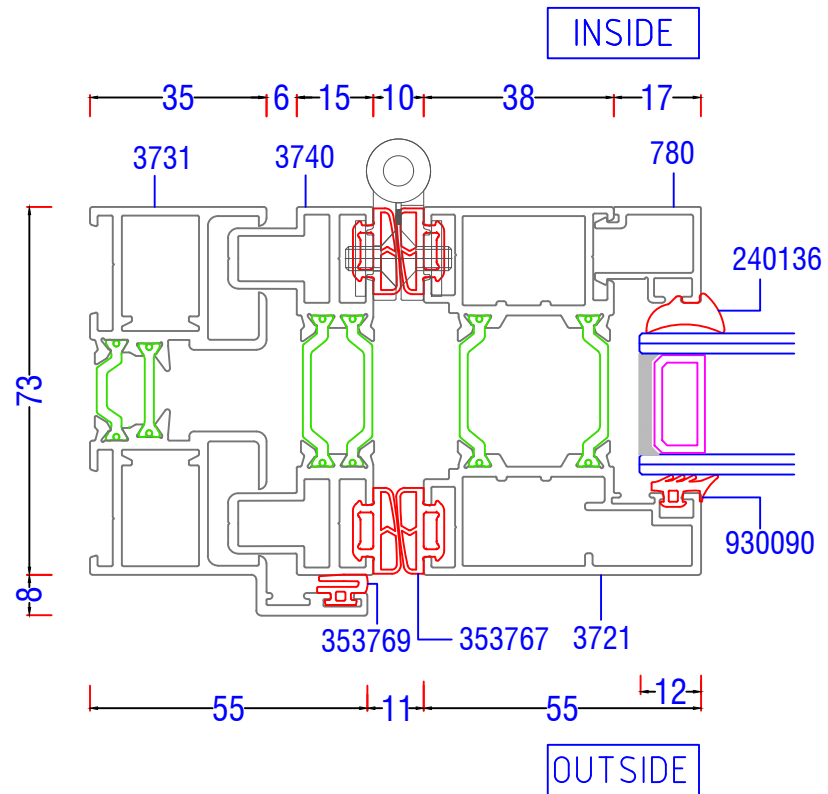
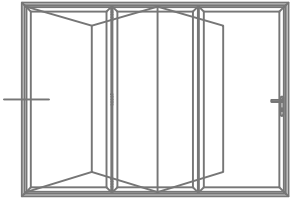

UNIFOLD - Typical Sections

Interlock - T-Handle Open Out

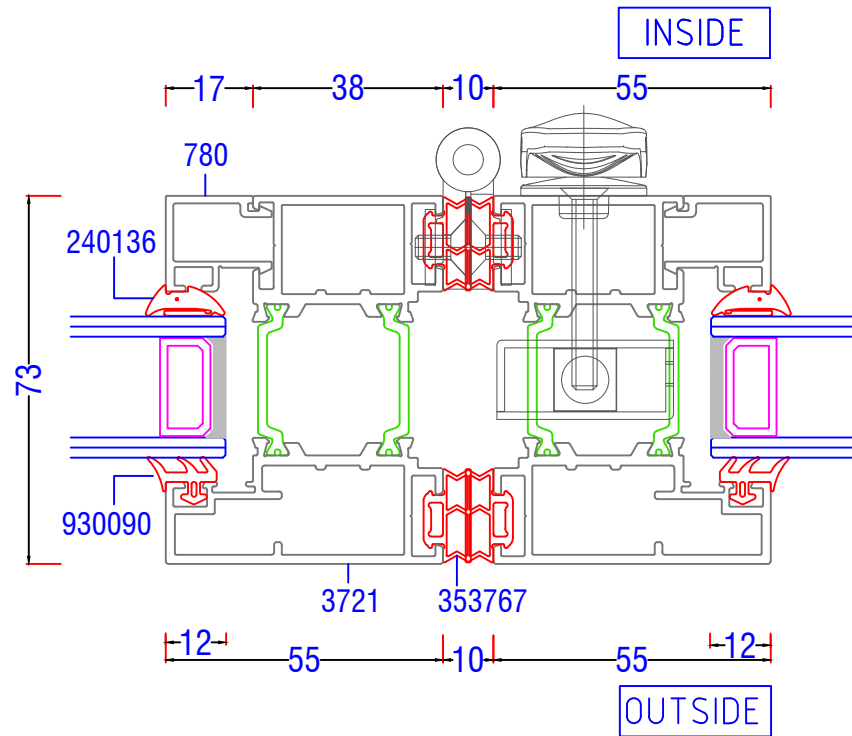
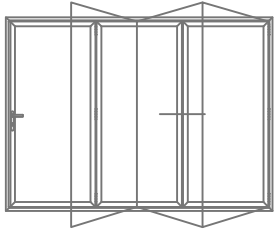

UNIFOLD- Typical Sections

Interlock - T-Handle Open In

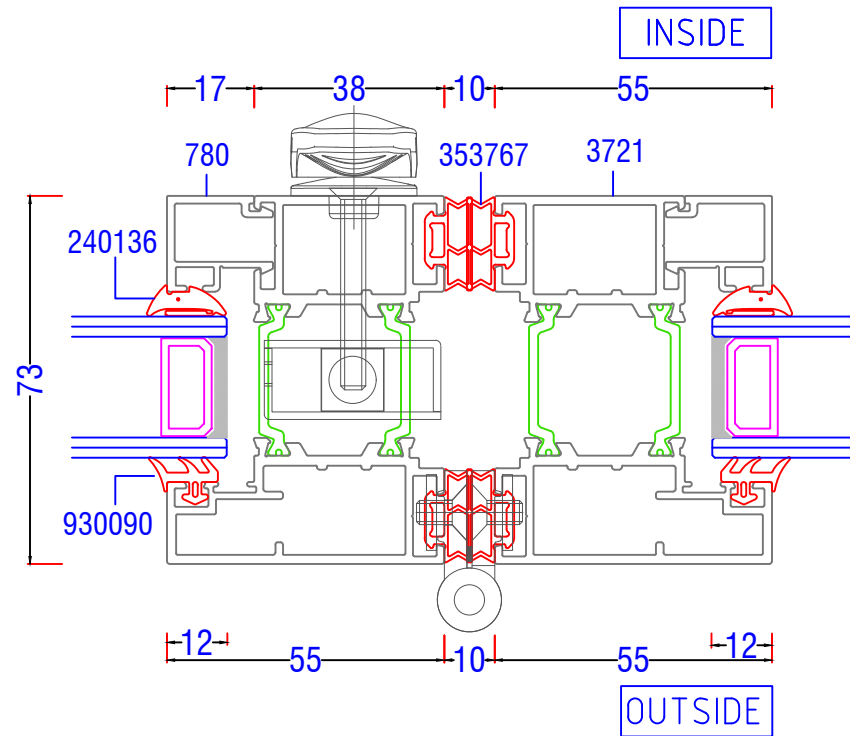
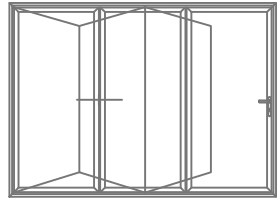

UNIFOLD - Typical Sections

Meeting - Traffic To Even Open Out

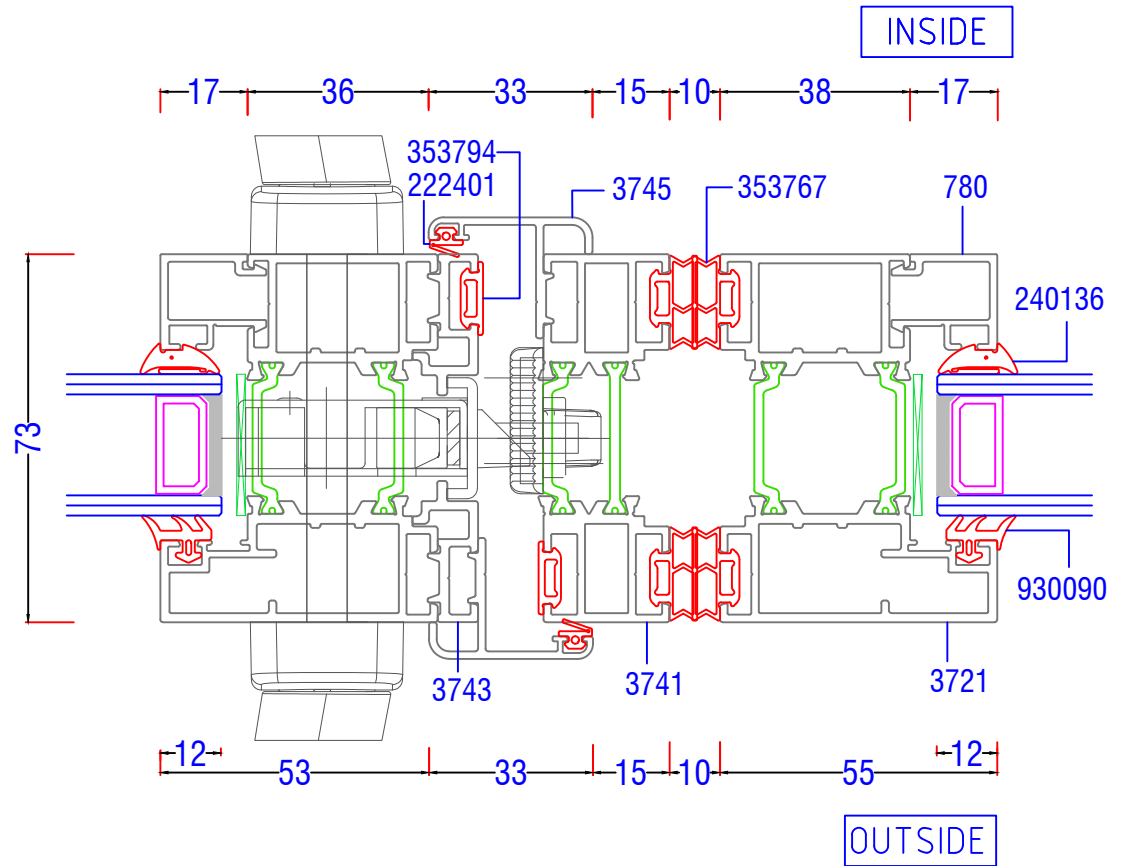
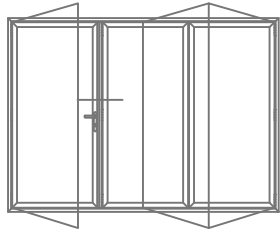

UNIFOLD - Typical Sections

Jamb - Traffic Door Open Out

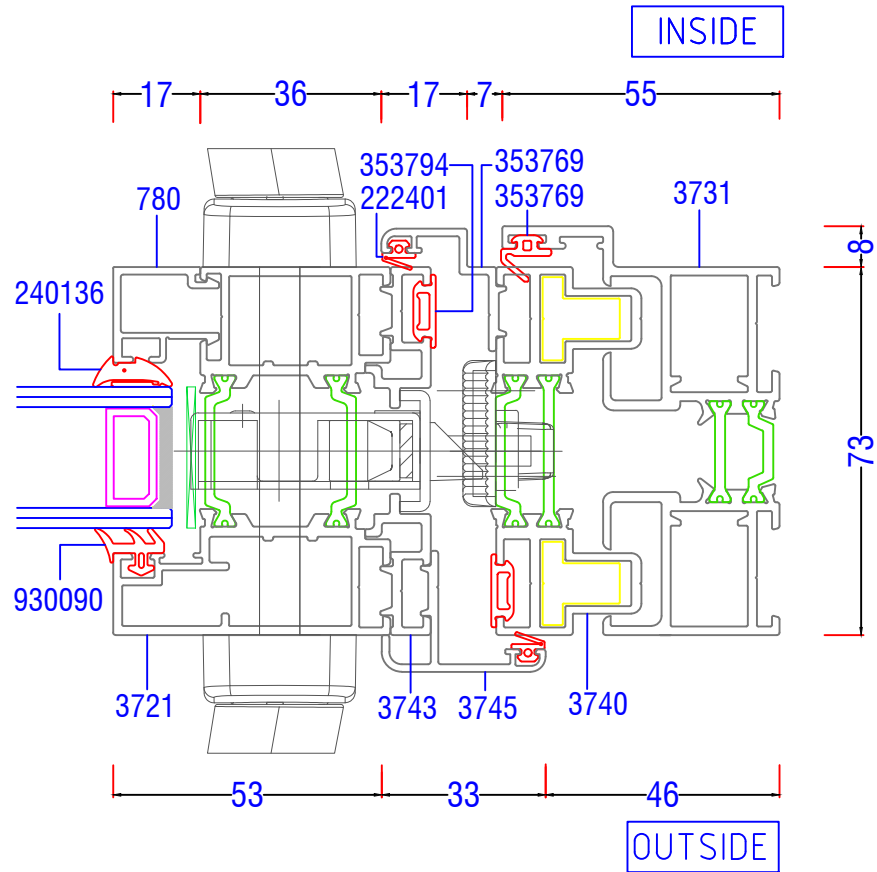
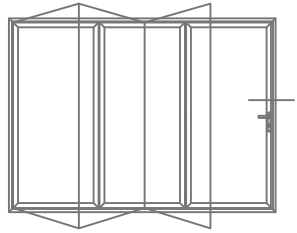

UNIFOLD - Typical Sections

Jamb - Traffic Door Open In

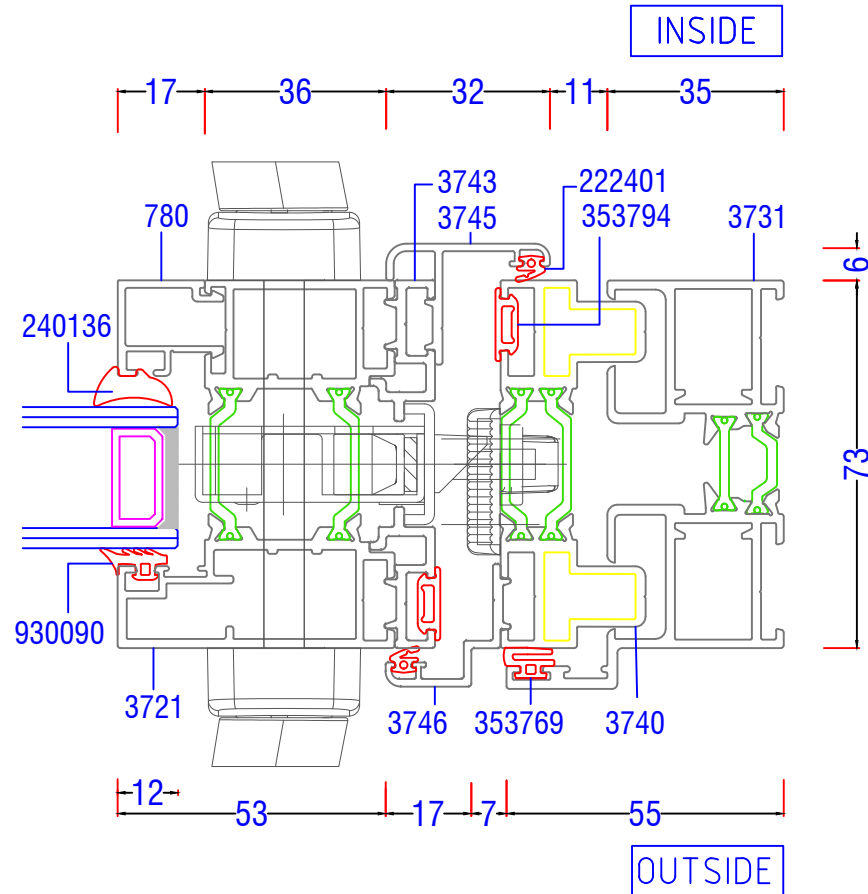
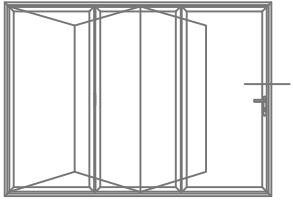

UNIFOLD - Typical Sections

Meeting - Traffic To Odd Open Out

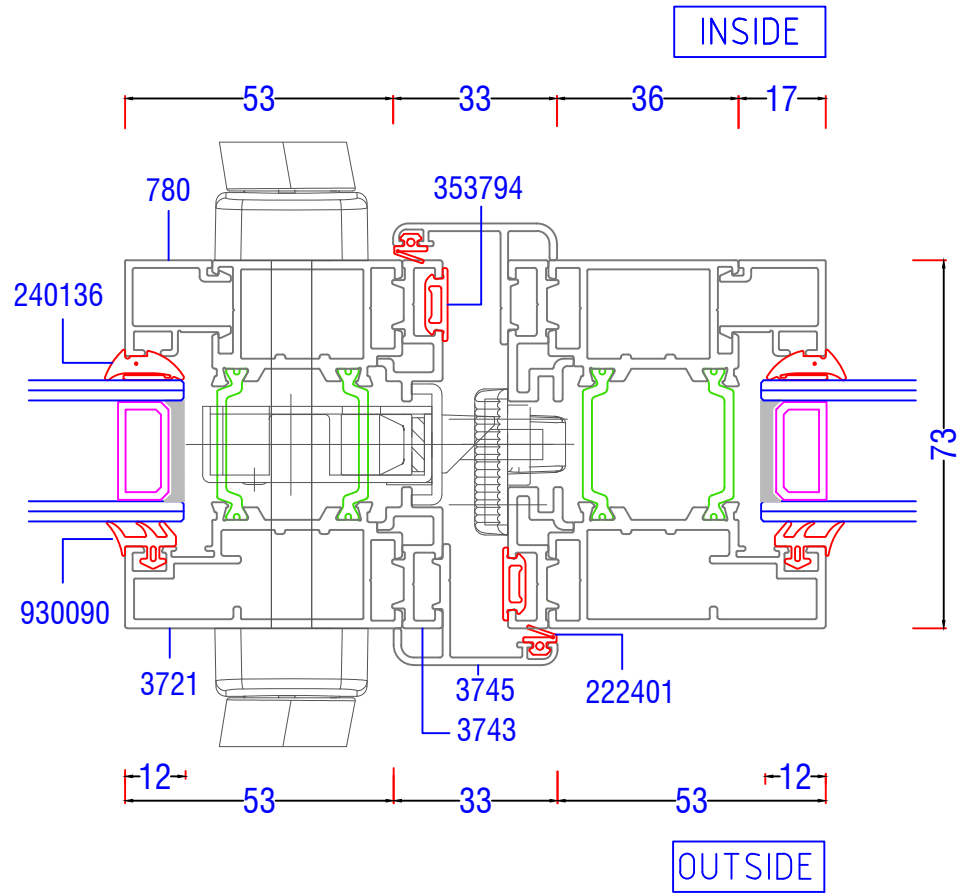
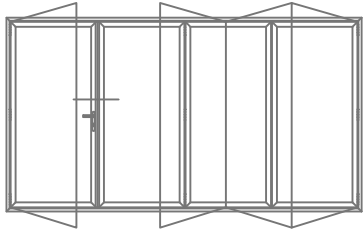

UNIFOLD - Typical Sections

Meeting - EvenTo Even Open Out - No Traffic Door

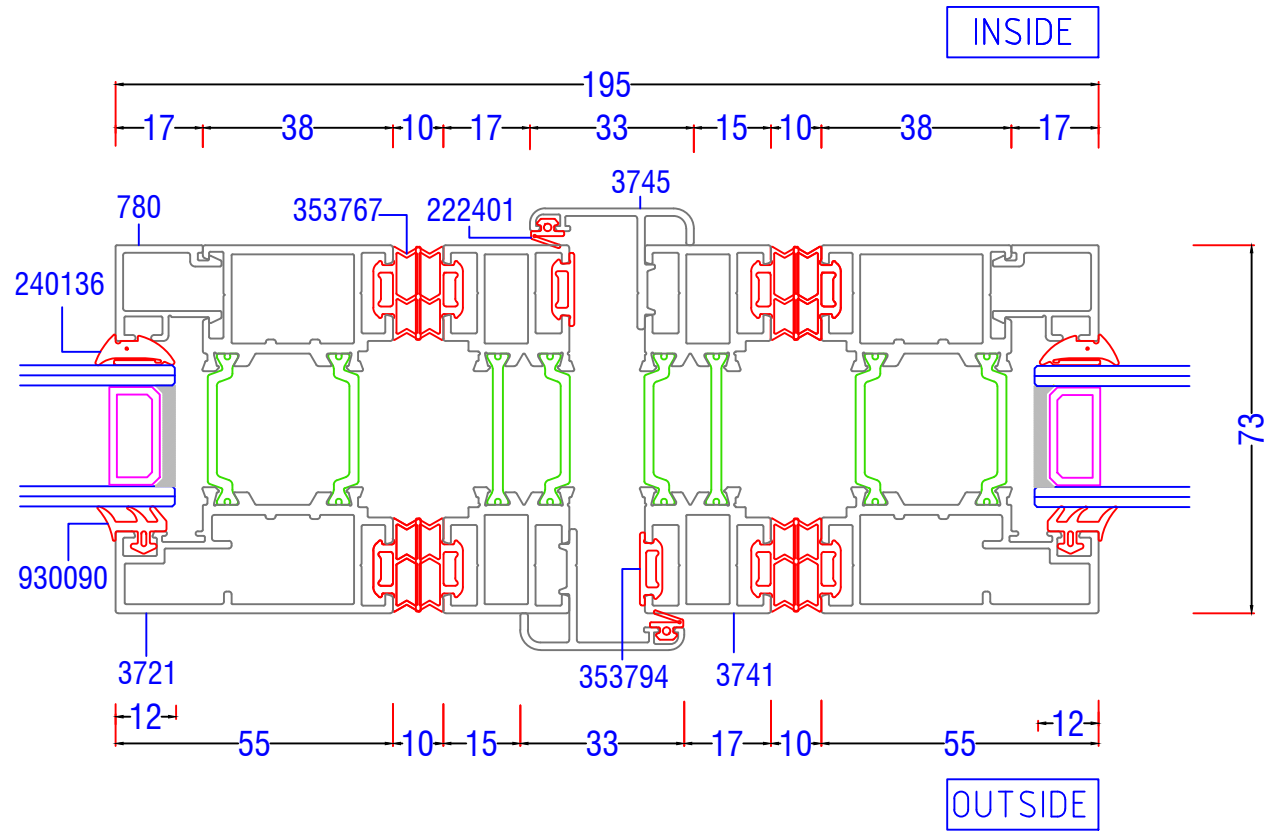
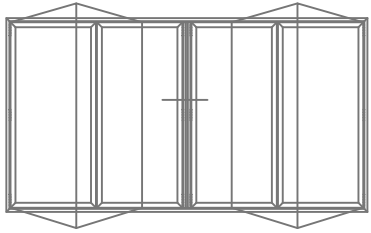

UNIFOLD - Typical Sections

Jamb - Even Configuration - No Traffic Door

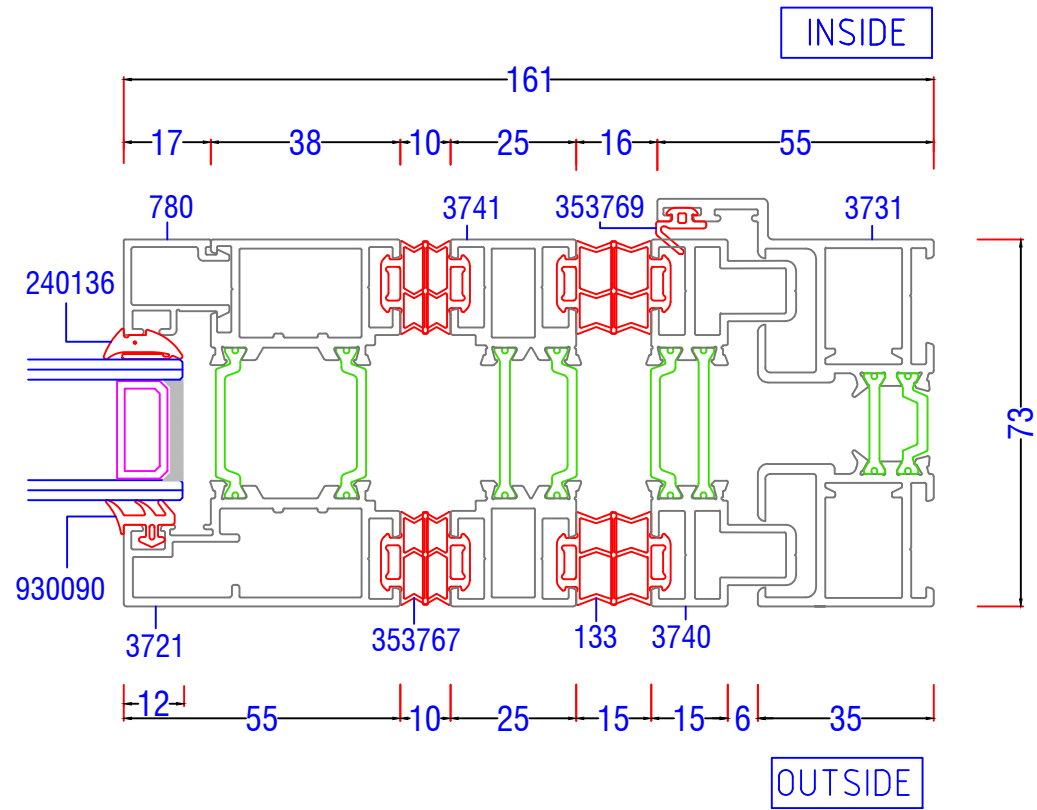
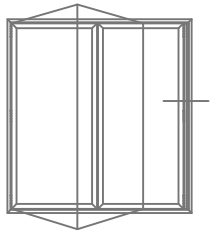

UNIFOLD - Typical Sections

Threshold - Cill Options

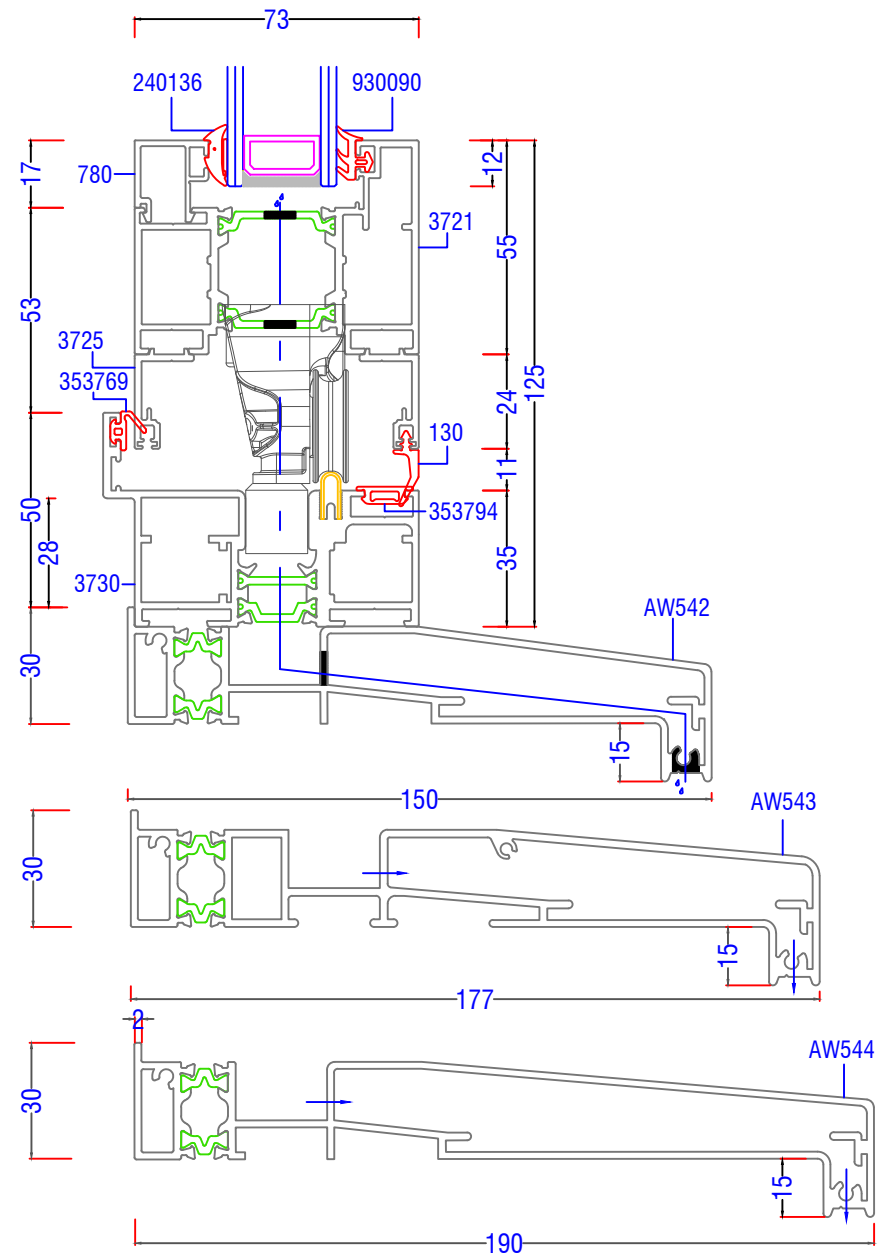
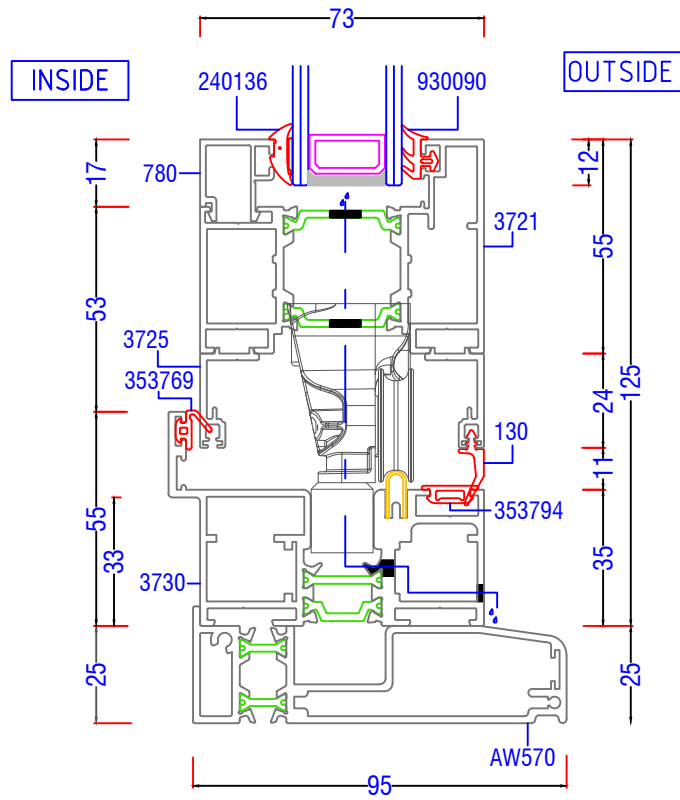
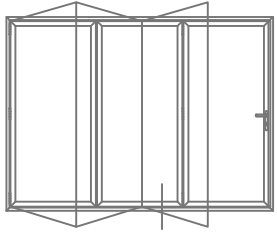

UNIFOLD - Typical Sections

Threshold - Cill Nose option

