

A-A

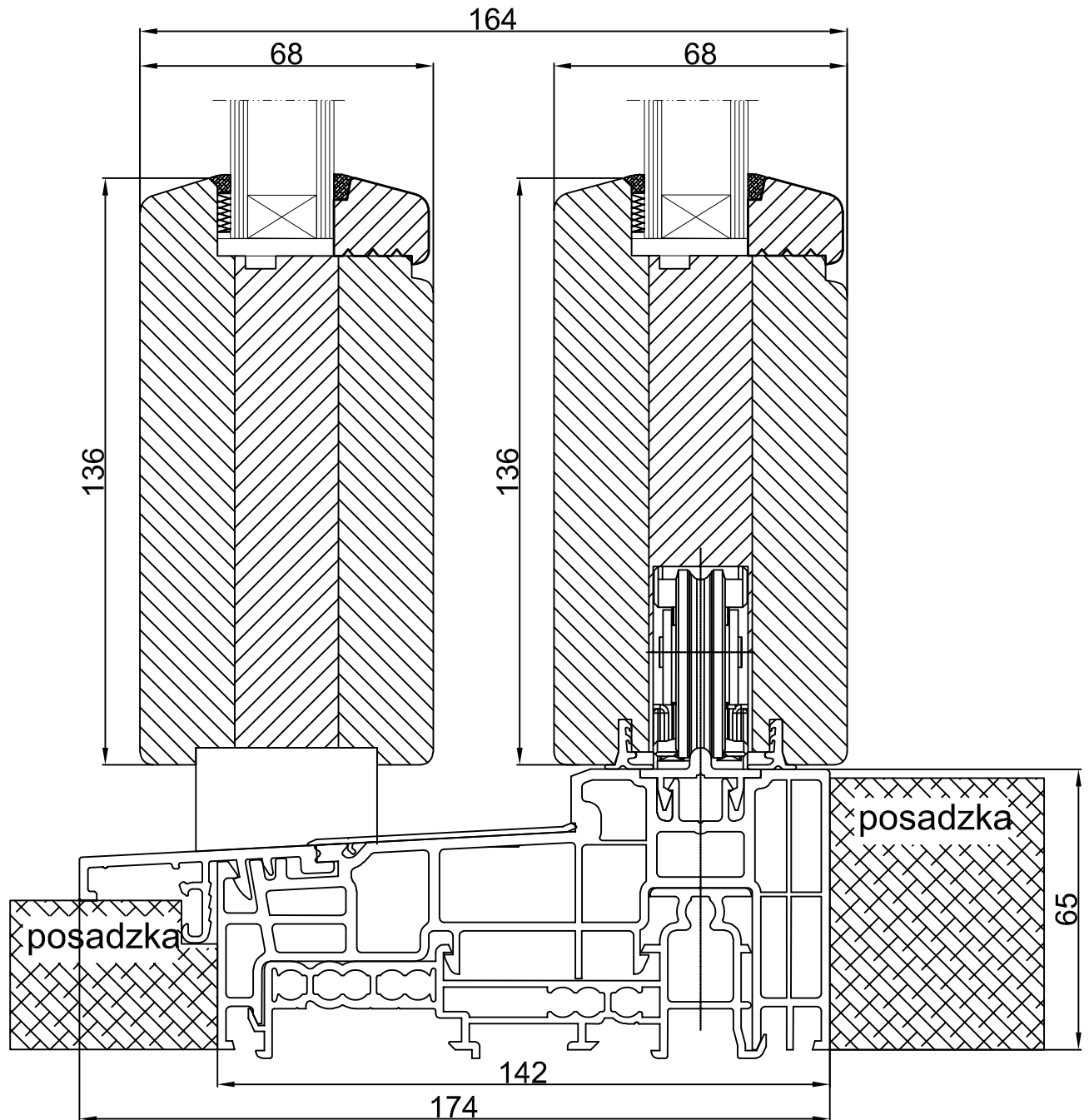

Przekrój	Próg okna balkonowego HS	Nr rysunku	B_STD68_106_A
Profil	STANDARD 68mm	Skala	1:1
Detal	Próg aluminiowy systemowy GU SCHEMAT A	Format	A3

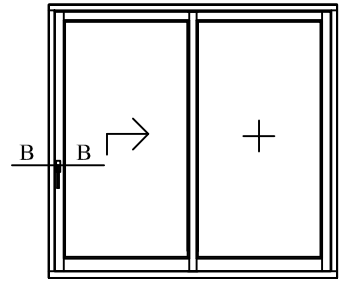

B-B

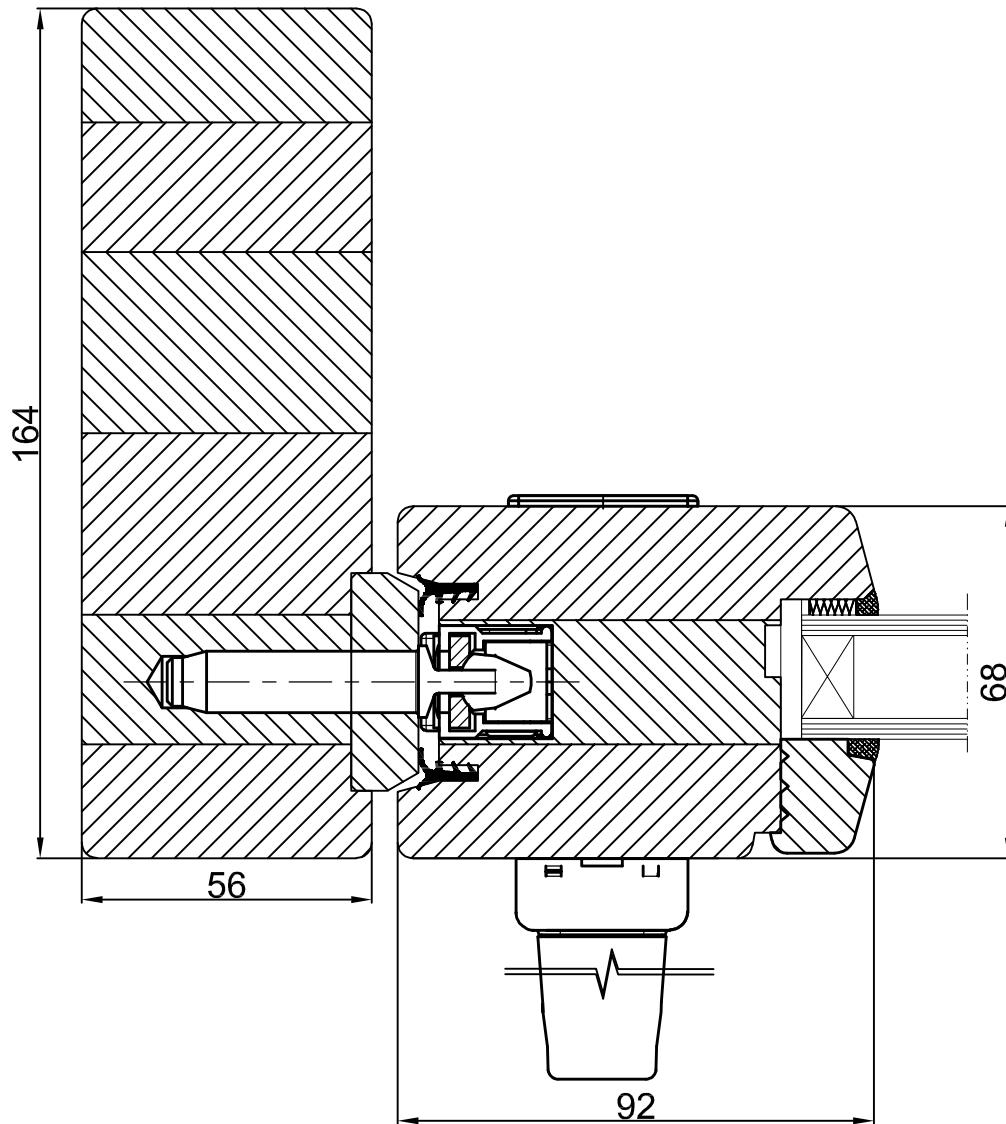

Przekrój	Stojak okna balkonowego HS	Nr rysunku	B_STD68_107_A
Profil	STANDARD 68mm	Skala	1:1
Detal	Lewy stojak okna balkonowego HS	Format	A3

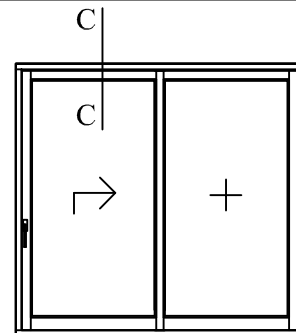

C-C

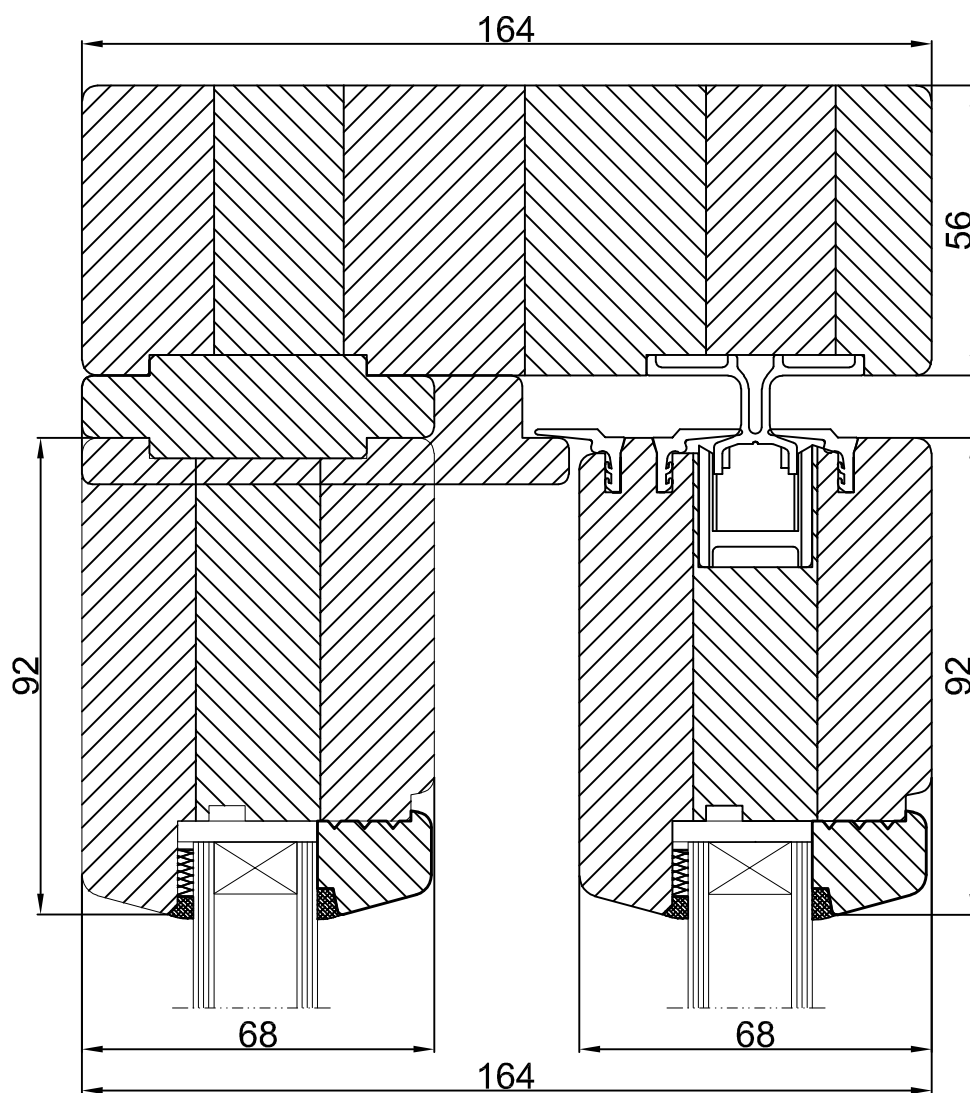

Przekrój	Nadproże okna balkonowego HS	Nr rysunku	B_STD68_108_A
Profil	STANDARD 68mm	Skala	1:1
Detal	Nadproże okna balkonowego HS SCHEMAT A	Format	A3

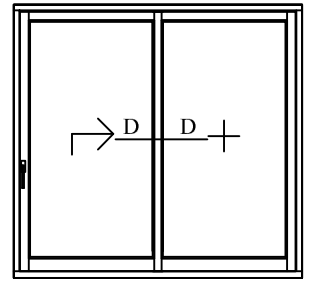

D-D

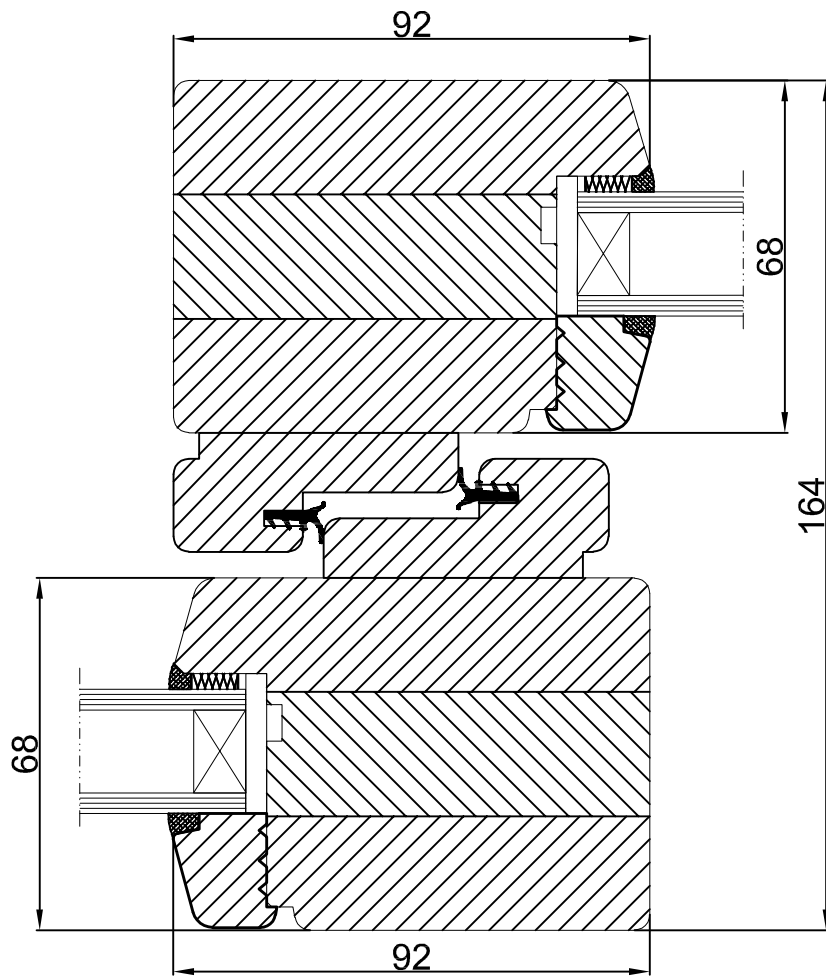

Przekrój	Słupek okna balkonowego HS	Nr rysunku	B_STD68_109_A
Profil	STANDARD 68mm	Skala	1:1
Detal	Słupek - SCHEMAT A	Format	A3

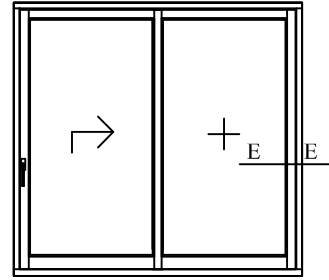

E-E

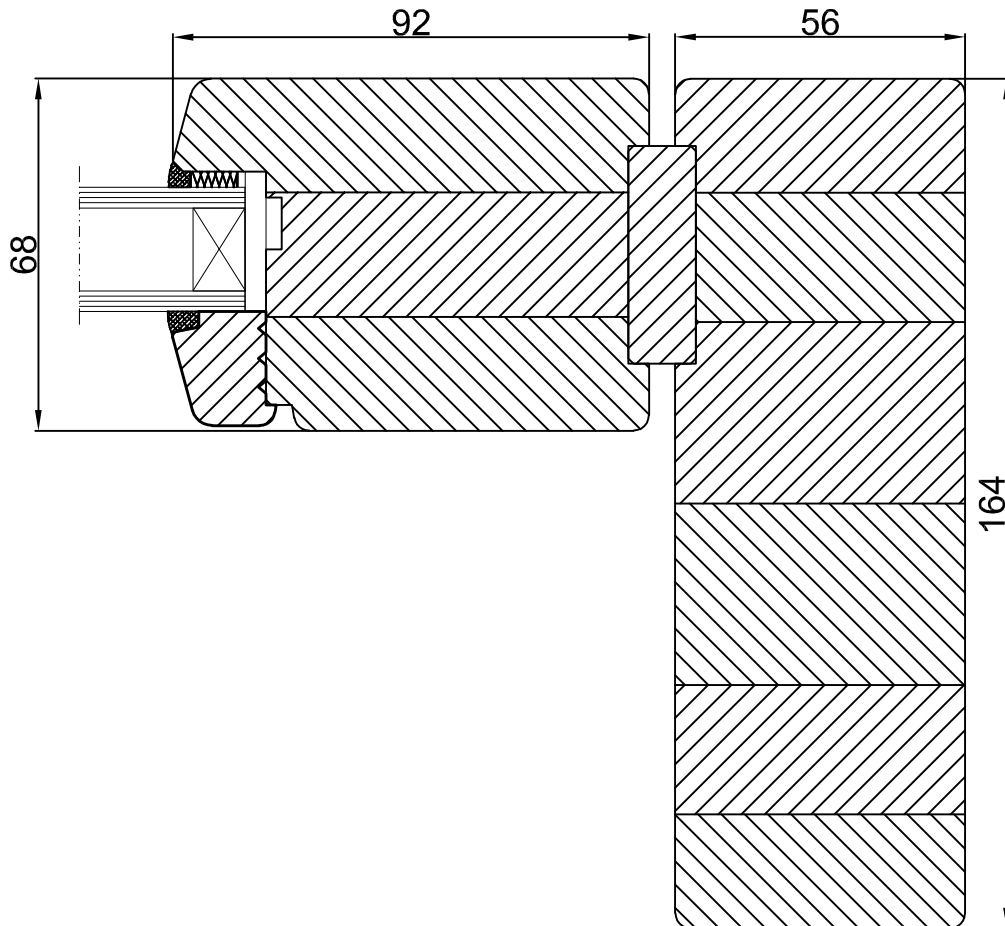

Przekrój	Stojak okna balkonowego HS	Nr rysunku	B_STD68_110_A
Profil	STANDARD 68mm	Skala	1:1
Detal	Prawy stojak okna balkonowego HS	Format	A3